



Cambridge IGCSE™

CANDIDATE
NAME

CENTRE
NUMBER

--	--	--	--	--

CANDIDATE
NUMBER

--	--	--	--



PHYSICS

0625/51

Paper 5 Practical Test

May/June 2021

1 hour 15 minutes

You must answer on the question paper.

You will need: The materials and apparatus listed in the confidential instructions

INSTRUCTIONS

- Answer **all** questions.
- Use a black or dark blue pen. You may use an HB pencil for any diagrams or graphs.
- Write your name, centre number and candidate number in the boxes at the top of the page.
- Write your answer to each question in the space provided.
- Do **not** use an erasable pen or correction fluid.
- Do **not** write on any bar codes.
- You may use a calculator.
- You should show all your working and use appropriate units.

INFORMATION

- The total mark for this paper is 40.
- The number of marks for each question or part question is shown in brackets [].

For Examiner's Use	
1	
2	
3	
4	
Total	

This document has **12** pages. Any blank pages are indicated.

- 1 In this experiment, you will investigate the period of a pendulum. Carry out the following instructions, referring to Fig. 1.1 and Fig. 1.2.

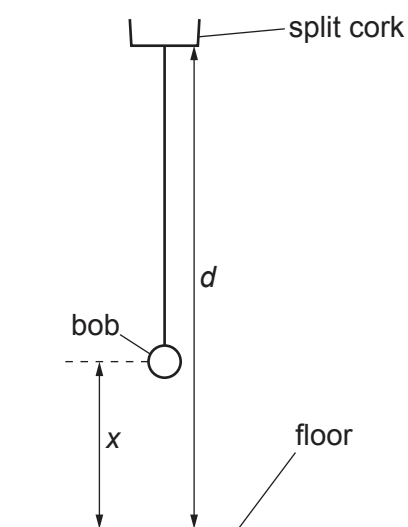

Fig. 1.1

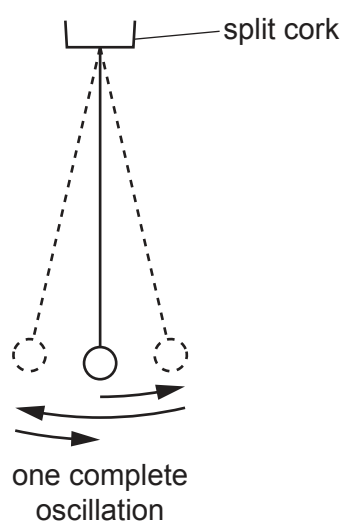

Fig. 1.2

A pendulum has been set up for you as shown in Fig. 1.1.

- (a) Measure the distance d between the bottom of the split cork and the floor.

$d = \dots\dots\dots$ cm [1]

This distance d must remain constant throughout the experiment.

- (b)
- Adjust the length of the pendulum until the distance x , measured from the centre of the bob to the floor, is 50.0 cm.
 - Displace the bob slightly and release it so that it swings. Fig. 1.2 shows one complete oscillation of the pendulum.
 - Measure, and record in Table 1.1, the time t for 10 complete oscillations.
 - Calculate, and record in Table 1.1, the period T of the pendulum. The period is the time for one complete oscillation.
 - Calculate, and record in Table 1.1, T^2 . [2]

Table 1.1

x/cm	t/s	T/s	T^2/s^2
50.0			
45.0			
40.0			
35.0			
30.0			

- (c) Repeat the procedure in (b) using $x = 45.0$ cm, 40.0 cm, 35.0 cm and 30.0 cm. [3]
- (d) Plot a graph of T^2/s^2 (y -axis) against x/cm (x -axis). You do **not** need to start your axes at the origin (0,0).

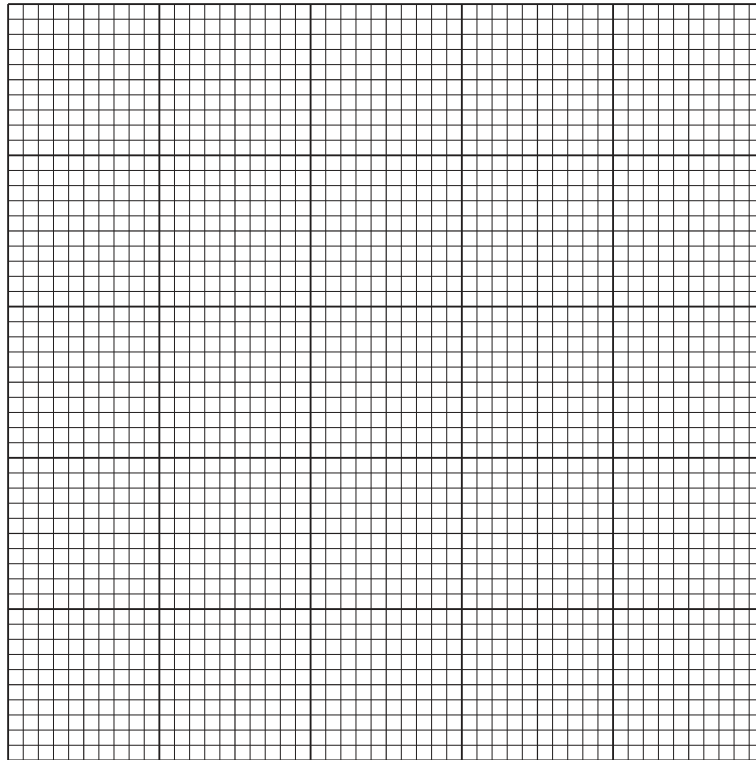

[4]

- (e) Explain why timing 10 oscillations gives a more accurate result for the period T than timing one oscillation.

.....

..... [1]

[Total: 11]

2 In this experiment, you will investigate resistance.

Carry out the following instructions, referring to Fig. 2.1. The circuit has been set up for you.

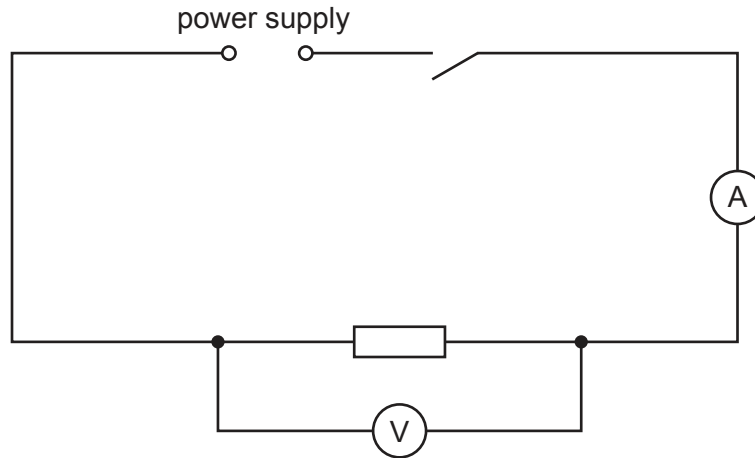

Fig. 2.1

(a) Close the switch.

(i) Record the current I_1 in the circuit.

$$I_1 = \dots\dots\dots [1]$$

(ii) Record the potential difference (p.d.) V_1 across the resistor.

$$V_1 = \dots\dots\dots [1]$$

Open the switch.

(iii) Calculate the resistance R_1 of the resistor using the equation $R_1 = \frac{V_1}{I_1}$.

$$R_1 = \dots\dots\dots [1]$$

(b) Disconnect the voltmeter.

Connect the second resistor provided in **series** with the first resistor.

Connect the voltmeter across both resistors.

Close the switch.

- Record the current I_2 in the circuit.

$$I_2 = \dots\dots\dots$$

- Record the potential difference (p.d.) V_2 across the resistors.

$$V_2 = \dots\dots\dots$$

Open the switch.

- Calculate the resistance R_S of the resistors in series using the equation $R_S = \frac{V_2}{I_2}$.

$$R_S = \dots\dots\dots [2]$$

(c) Disconnect the voltmeter. Connect the second resistor in **parallel** with the first resistor.

Connect the voltmeter across both resistors.

Close the switch.

- Record the current I_3 in the circuit.

$$I_3 = \dots\dots\dots$$

- Record the potential difference (p.d.) V_3 across the resistors.

$$V_3 = \dots\dots\dots$$

Open the switch.

- Calculate the resistance R_P of the resistors in parallel using the equation $R_P = \frac{V_3}{I_3}$.

$$R_P = \dots\dots\dots [2]$$

(d) Complete the circuit diagram to show the circuit you used in part (c).

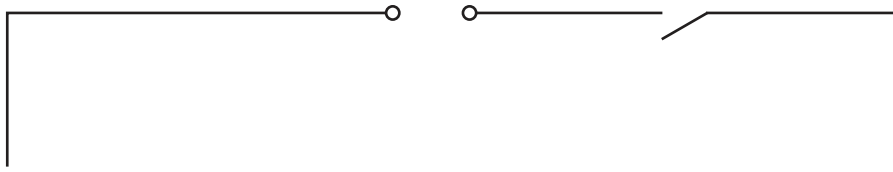

[2]

(e) Describe how you would extend part (c) of this experiment to investigate the relationship between the combined resistance of identical resistors connected in parallel and the number of resistors. You are **not** required to do this investigation.

.....

.....

.....

..... [2]

[Total: 11]

3 In this experiment, you will investigate the refraction of light in the material of a transparent block.

Carry out the following instructions, using the separate ray-trace sheet provided. You may refer to Fig. 3.1 for guidance.

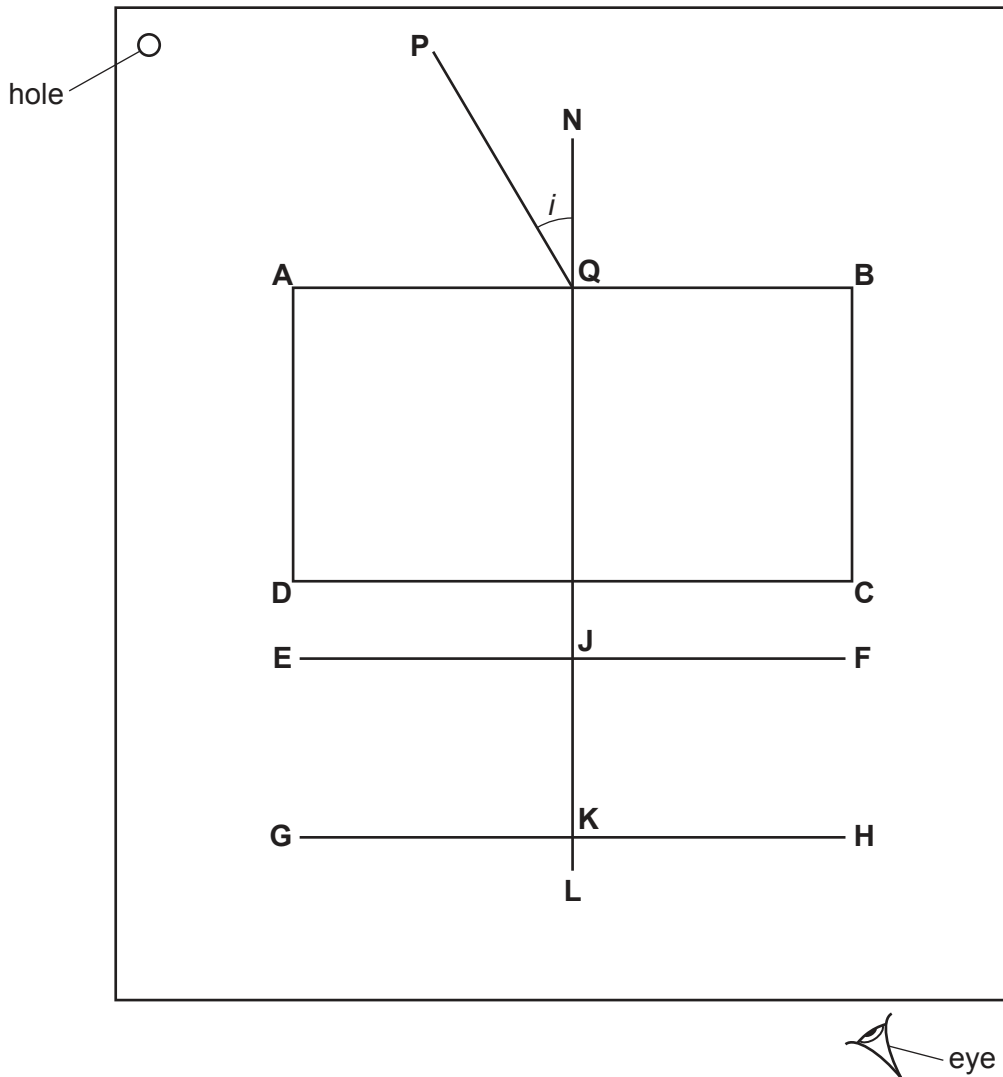

Fig. 3.1

- (a)
- Place the transparent block, largest face down, on the ray-trace sheet supplied. The block should be approximately in the middle of the paper.
 - Draw and label the outline of the block **ABCD**, as shown in Fig. 3.1.
 - Remove the block and draw a normal at the centre of side **AB**. Continue the normal so that it passes through side **CD** of the block. Label the normal **NL**.
 - Label the point **Q** where **NL** crosses **AB**.
 - Draw a line **EF** parallel to **CD** and 2.0 cm below **CD**.
 - Label the point **J** where **NL** crosses **EF**.
 - Draw a line **GH** parallel to **CD** and 7.0 cm below **CD**.
 - Label the point **K** where **NL** crosses **GH**.

[2]

- (b) • Draw the line **PQ** at an angle $i = 30^\circ$ to the normal as shown in Fig. 3.1.
- Place the paper on the pin board.
- Place two pins, P_1 and P_2 , on line **PQ** at a suitable distance apart for this experiment.
- Replace the block and look from the position of the eye shown in Fig. 3.1 to observe the images of P_1 and P_2 through side **CD** of the block. Adjust your line of sight until the images of P_1 and P_2 appear one behind the other.
- Place a pin P_3 on line **EF** between your eye and the block so that the images of P_1 and P_2 seen through the block appear behind P_3 .
- Place a pin P_4 on line **GH** between your eye and the block so that P_3 , and the images of P_1 and P_2 seen through the block, appear behind P_4 .
- Label the positions of P_1 , P_2 , P_3 and P_4 .
- Remove the pins.

[2]

- (c) (i) Measure and record the length a of the line from **J** to P_3 .

$a = \dots\dots\dots$ [1]

- (ii) Measure and record the length b of the line from **K** to P_4 .

$b = \dots\dots\dots$ [1]

- (iii) Calculate $\frac{b}{a}$.

$\frac{b}{a} = \dots\dots\dots$ [2]

- (d) State **one** precaution that you took in order to produce an accurate ray trace.

.....
 [1]

- (e) A student plans to test the suggestion that, in this experiment, $\frac{b}{a}$ is a constant for all possible values of i . List suitable values of i that the student could use.

..... [2]

Tie your ray-trace sheet into this booklet between pages 8 and 9.

[Total: 11]

- 4 A student investigates the rate of cooling, in air, of heated blocks made of different metals. The temperature of each block is increased by placing it in hot water.

Plan an experiment to investigate how the rate of cooling depends on the metal from which each block is made.

You are **not** required to carry out this experiment.

The following apparatus is available to the student:

cylindrical blocks of different metals, each with a hole for a thermometer, as shown in Fig. 4.1 a thermometer.

Other apparatus normally available in a school laboratory can also be used.

In your plan, you should:

- list any additional apparatus required
- explain briefly how you would carry out the investigation, including the measurements you would take
- state the key variables to be kept constant
- draw a suitable table, with column headings, to show how you would display your readings (you are **not** required to enter any readings in the table)
- explain how you would use the results to reach a conclusion.

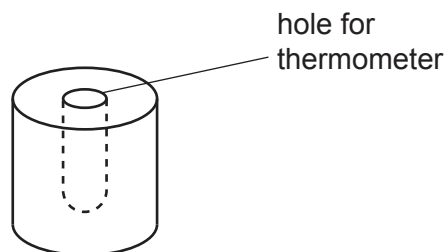

Fig. 4.1

BLANK PAGE

Permission to reproduce items where third-party owned material protected by copyright is included has been sought and cleared where possible. Every reasonable effort has been made by the publisher (UCLES) to trace copyright holders, but if any items requiring clearance have unwittingly been included, the publisher will be pleased to make amends at the earliest possible opportunity.

To avoid the issue of disclosure of answer-related information to candidates, all copyright acknowledgements are reproduced online in the Cambridge Assessment International Education Copyright Acknowledgements Booklet. This is produced for each series of examinations and is freely available to download at www.cambridgeinternational.org after the live examination series.

Cambridge Assessment International Education is part of the Cambridge Assessment Group. Cambridge Assessment is the brand name of the University of Cambridge Local Examinations Syndicate (UCLES), which itself is a department of the University of Cambridge.